



CM

OPERATIONAL MANUAL



MADE IN USA

TABLE OF CONTENTS

	Page
CALORIE BURN GRAPH	3
GENERAL INTRODUCTION	4
SELECTING EXERCISE TIME	4
CALORIE BURN RATE	4-5
STEPPER USER GUIDE	5
CLIMBING USER'S GUIDE	5
MODULE DISPLAY	5-6-7
SELECTING AN OPPONENT	6
SELECTING A LANDMARK	6
USING HYDRAULICS TO CONTROL SPEED	7
VERSACLIMBER SPECIFICATIONS	8
UNPACKING INSTRUCTIONS	8
ASSEMBLY INSTRUCTIONS	9-12
ASSEMBLY INSTRUCTIONS FOR HIGH-TRI & HIGH-FIVE	12
MAINTENANCE INSTRUCTIONS	13
WALL MOUNT INSTRUCTIONS	14-16
TROUBLE SHOOTING	17-18
SPARE PARTS.....	19
WARRANTY	19-20
CONTACT INFO	21

VersaClimber Burns More Fat & Calories in 20 Minutes Than Ellipticals, Treadmills, Steppers, and Spin Bikes.

Calories Burned in 20 Minutes

VersaClimber provides a more complete, total body exercise by toning the arms, chest, shoulders, back, abs, legs, glutes and more in one fluid motion. Most cardio pieces only work the lower body which requires greater amounts of workout times to burn the needed calories for weight loss. Cut your work out time in half while achieving better results simply by using a VersaClimber.

#1 Calorie Burner:

Studies show the VersaClimber is the ultimate fat burner. When it comes to burning more calories and fat VersaClimber is the leader.

Saves Time:

Great for people who don't have a lot of time to spend working out. You get a complete full body workout in 20 minutes or less.

Space Efficient:

With only a 43" x 46" footprint it requires the smallest amount of floor space of any total body exerciser on the market. Quality work out, better results in less space.

Non-Impact:

The VersaClimber's smooth, fluid stride is a safe non-impact exercise. There's no pounding of knees, joints or hips.

Versatile:

Push, Pull, Step, and Climb. Legs only. Arms only or both arms and legs. It was designed with versatility in mind. Step, walk, jog, or sprint against gravity. Use it as a stepper by simply holding on to the hand rails or a total body vertical trainer.

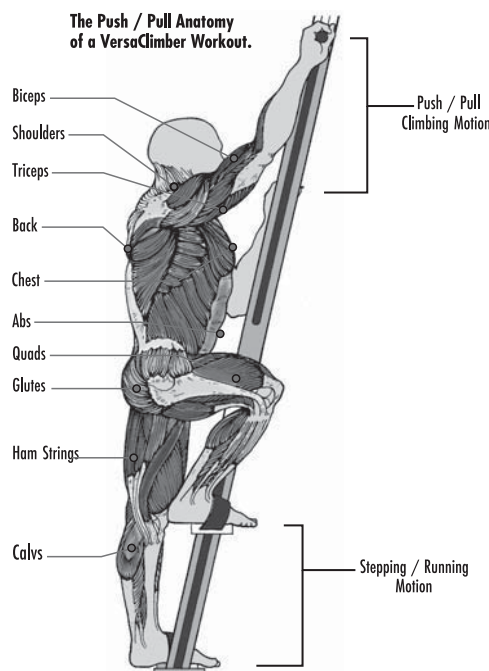
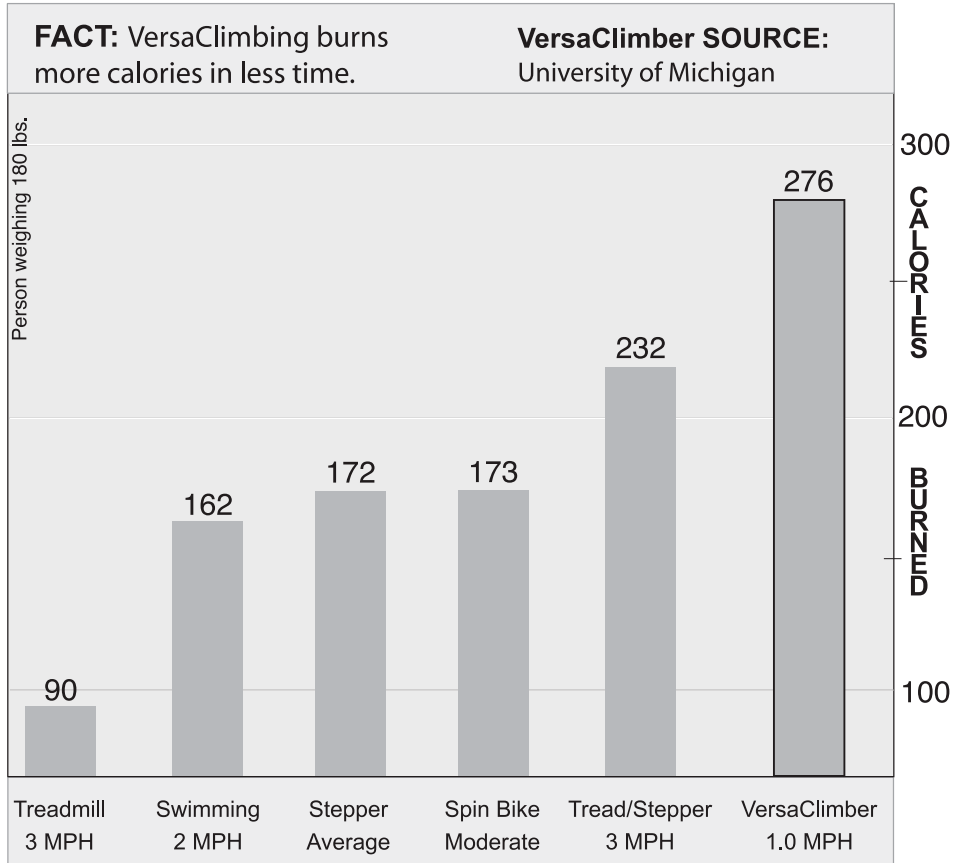

" I absolutely love my VersaClimber it was the best investment I've ever made and worth every penny...I lost 10 lbs and inches around my waist." *Jeannine Johnson*

" People get frustrated because they work out 5x a week and are not getting anywhere. Typically they are walking or using gliders...I use the VersaClimber, it is a superior piece of cardiovascular equipment." *Peter Raphael, MD*

" ...outstanding cardiovascular workout in approximately half the time." *Casey Schutte Fitness Professional CPT*

NOTE

BEFORE EXERCISING ON THE VERSACLIMBER, READ THIS OPERATION MANUAL THOROUGHLY. INSTRUCT OTHERS HOW TO USE THE MACHINE IN ACCORDANCE WITH THE PROCEDURES OUTLINED IN THIS MANUAL. ADDITIONAL MANUALS ARE AVAILABLE UPON REQUEST FROM HEART RATE, INC.

BEFORE BEGINNING THIS OR ANY OTHER EXERCISE PROGRAM, CONSULT YOUR PHYSICIAN. THIS IS ESPECIALLY IMPORTANT FOR THOSE INDIVIDUALS OVER THE AGE OF 30 AND THOSE WHO HAVE KNOWN HEALTH PROBLEMS. HRI ASSUMES NO RESPONSIBILITY FOR PERSONAL INJURY OR PROPERTY DAMAGE SUSTAINED BY OR THROUGH THE USE OF THE VERSACLIMBER.

GENERAL INTRODUCTION

The VersaClimber, introduced in 1981, was the first climbing exercise machine on the market; and to this day remains the leader as a true total body conditioning unit. This full body climbing exercise machine provides an alternating arm and leg action against gravity with variable force, stroke length and speed. All the major muscles of the arms, chest, shoulders, back, hips, butt and legs are used while climbing. The VersaClimber has been proven worldwide and is a widely accepted total body exerciser that is used by health clubs, sports medicine facilities, military, fire departments, corporate gyms and wherever groups of people gather to exercise.

To climb, the person stands in a vertically erect position with both feet level on pedals while grasping two handgrips set at about shoulder height. To initiate climbing motion, step down on one foot pedal while pushing up on the hand grip. When the foot and hand move vertically downward, the other foot and hand move vertically upward and then alternate synchronously. A cyclic action of the arms and legs is performed that simulates motion of climbing an endless ladder for any selected step height, time, rate and distance. A microcomputer monitors and displays climbing performance, heart rate, calories, distance, time and gives audible instructions and motivational messages during the exercise. The machine is oriented at a 75-degree climb angle.

NOTE:

Don't Climb Too Fast. Beginners Should Take a 6 inch Step At a Gentle Pace

First time users of the VersaClimber have a tendency to climb too fast and to take too long a step. Until users become thoroughly familiar with the VersaClimber, it is important to take short, slow steps. To maintain a shock and trauma free motion, it is mandatory not to "bottom out" or impact the pedals at the end of each stroke.

SELECTING EXERCISE TIME

If you are not already warmed up, a warm up period of at least 5 to 10 minutes should be included in each VersaClimber workout. Taking a short step at a slow climbing speed during the warm up period is the key to a great workout. The first time user can easily climb for 15 to 20 minutes by including a slow 5 minute warm up and a 3 to 5 minute cool down period. With repetitive use it is possible to build up to longer climbs at higher speeds.

Many individuals enjoy 60 minutes or more of uninterrupted climbing. After each workout, note exercise time, climbing speed and height climbed for establishing a goal for future sessions. Use heart rate and perceived exertion to determine if you are at a comfortable exercise level. Remember that work intensity and calorie burn rate is based on climbing speed. If the exercise is too hard, slow down.

CALORIE BURN RATE

Full body climbing ranks highest in calories burned even though climbing speed is slower than other activities. First time users often try to maintain the speed they use in other activities and tend to over exert themselves. It is important to remember that because VersaClimbing is a total body climb against gravity, it is not necessary to climb at a high rate of speed demonstrated as follows.

CALORIES ACTIVITY

(For a 150 lb person)

	<u>SPEED</u>	<u>Calories Burned Per Hour</u>
Walking	3.0 mph	228
Bicycling	9.4 mph	384
Swimming	2.0 mph	486
Running	7.5 mph	792
Stepping	1.9 mph	864
VersaClimbing	0.9 mph	972

STEPPING USER GUIDE

The side handrails not only provide support while getting on and off the VersaClimber but they offer the option of Stair Stepping. By holding the handrails to the side of the body and stepping with the legs only, the gluts, quads, hamstrings, calves and shins can achieve a complete lower body aerobic and strength exercise.



Two cardio machines in one.

Use side hand rails for use as a lower body stepper

The CM features a 1-10 inch step height. By shifting the hands from the stationary handrails to the moving handgrips, the machine automatically converts from a stepping machine into a total body climbing machine or back to a stepping machine simply by changing hand position.

CLIMBING USER GUIDE

Hold handrails for support and step up on the pedals until both **feet are level**. With both feet at the same level, position handgrips at about chin or shoulder height. Adjust handles if necessary by depressing the pin at the end of the handgrip. Remove the handgrip and reinsert it fully into another position and release the pin.

NOTE:

WHEN GRASPING THE HAND RAILS OR HAND GRIPS, KEEP FINGERS AND THUMBS ON THE FOAM PADDING OF THE HANDRAILS OR RUBBER GRIPS OF THE HANDLES. DO NOT GRASP OR EXTEND ANY PORTION OF THE HAND BEYOND THE FLANGES OF THE MOVING HAND GRIPS. DO NOT HOLD ONTO THE VERTICAL POST.

QUICK START

Push QUICK START on the module and follow verbal user instructions. Time, Rate, Distance, Step Height and other information is displayed. See page 6 for detailed display functions including Heart Rate and Calories.

Begin climbing by taking a **very short** step stroke length of approximately 5 inches at a speed of 20 feet per minute for approximately 5 minutes. After 5 minutes the step height and climbing speed can be gradually increased if desired.

To maintain a shock and trauma free motion, do not, under any circumstances, “bottom out” at the end of each stroke.

CAUTION:

IMMEDIATELY DISCONTINUE THIS OR ANY EXERCISE IF THERE IS ANY DISCOMFORT, SHORTNESS OF BREATH OR DIZZINESS.

MODULE DISPLAY

The control module consists of 17 push buttons with associated back lit text descriptors, a 32 character LCD display and a voice message system which provides verbal instructions and motivation for new users. The text descriptors are back lit descriptions of what function or activity is currently associated to each button. Here is a brief discussion of the functions provided by each instruction.



YELLOW QUICK START BUTTON

When pressed, it clears the display of any previous information and verbally guides the first time user through a 15 minute workout.

SELECT AN OPPONENT

Press YELLOW QUICK START button, then press blue SELECT OPPONENT button repeatedly to select one of 6 virtual opponents to race against. Then press LOCK SELECT. Next, select ENTER TIME use yellow arrow keys up/down then press LOCK SELECT button. Start climbing.

OPPONENT

The opponent you select will climb at the average speed listed below. If you are not able to keep up with the opponent you selected, slow down and finish the 15 minute race. Select a slower opponent for the next workout.

	<u>SPEED</u> <u>FEET/MIN</u>	<u>15 MINUTES</u> <u>DISTANCE</u> <u>FEET</u>
1. BEGINNER	20	300
2. INTERMEDIATE	30	450
3. COMPETITOR	40	600
4. CHAMPION	50	750
5. ELIMINATOR	65	975
6. OLYMPIAN	90	1350

SELECT A LANDMARK

Press this button repeatedly to select one of six Landmark goals. Then press the LOCK SELECT button to start. This is a distance challenge. You climb at your own desired speed.

	<u>LANDMARK</u>	<u>HEIGHT</u>
1.	Washington Monument	554 FT
2.	Eiffel Tower	984 FT
3.	Moscow Tower	1,762 FT
4.	El Capitan	3,297 FT
5.	Vesuvius	3,900 FT
6.	Mount Olympus	9,731 FT

Select a landmark based on the total distance climbed during previous workouts.

ENTER WEIGHT

Press this button to enter your weight which is used to calculate caloric burn rate. Use the yellow LOCK SELECT arrows to raise or lower your weight in the display until it matches your weight within plus or minus five pounds (or two kilograms). Then press the LOCK SELECTION button to enter your weight into the computer.

ENTER TIME

Press this button to increase or decrease the default workout period of 15 minutes. Use the yellow LOCK SELECTION **arrows** to raise or lower the number in the display until the desired time is displayed. Then press the LOCK SELECTION button to enter your time into the computer.

LOCK SELECTION

Press this button to enter user selected values into the computer.

YELLOW LOCK SELECTION ARROWS

These buttons are used to raise or lower the number in the display.

“Upper” Left SELECT button.

Press this button to switch the display between ELAPSED TIME and TIME REMAINING in the workout period. The remaining time display stops at zero while the elapsed time continues counting up to 99 hours :59 minutes :59 seconds.

“Center” SELECT button.

Press this button to switch between TOTAL CALORIES and CALORIES PER HOUR.

“Upper” Right SELECT button.

If the machine is not running in one of the specialty modes (Opponent, Landmark, or Heart Rate Control) this button has no function as both has no function as both STROKE LENGTH and DISTANCE PER MINUTE will be displayed continuously. When any of the specialty modes are selected, this button will switch the display between STROKE LENGTH and DISTANCE PER MINUTE

“Lower Left” SELECT button. Press this button to switch between metric and imperial display units.

“Lower Right” SELECT button.

Press this button to switch between OPPONENT'S TOTAL DISTANCE and OPPONENT'S DISTANCE PER MINUTE. This button is only active when virtual **opponent mode** is selected.

VOLUME CONTROL

Press this blue oval button repeatedly to hear each of the voice instructions. Great for training tips and other key VersaClimber information.

YELLOW VOLUME CONTROL ARROWS

Use these buttons to raise or lower the voice message volume level. Push the down arrow 4 times to turn off voice feedback.

SPECIALTY MODES

Press this button to select HEART RATE CONTROL MODE. Polar chest strap must be worn. Enter target heart rate with yellow lock selection buttons. Press LOCK SELECT. Climb at suggested speed.

USING HYDRAULICS TO CONTROL SPEED

Beginners and individuals who are deconditioned may use the hydraulics to control their climbing speed, rather than working against the resistance. The hydraulic control knob is located at the bottom of the control console.

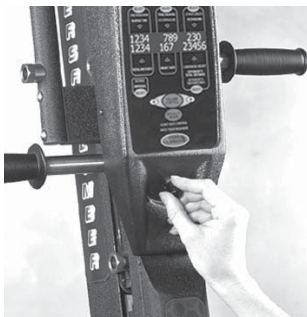

Clockwise rotation of the control knob, (to the right), slows the rate of motion (easier). Counterclockwise rotation of the control knob, (to the left), increases the rate of motion (harder). The rate of motion, (slower/faster), may be

changed without stopping any time during exercise. Start with the speed control knob fully rotated clockwise and gradually increase the climb rate to the desired speed by turning the control knob in the counterclockwise direction. Climb at the speed set by the resistance.

VersaClimbing uses many more muscles than jogging, pedaling, stepping or elliptical exercises and is therefore performed at a slower cyclic rate and speed. Speed in “Feet Per Minute” is an accurate guide for the amount of work being done.

A reasonable starting rate for a person in good condition would be about 60 to 80 feet per minute. After a few minutes of exercise, heart rate should be checked and the climb rate increased or decreased appropriately to bring the user to their target heart rate zone.

VERSACLIMBER SPECIFICATIONS

PHYSICAL SIZE

Height	7 feet, 10 Inches
Footprint	43 Inches x 46 Inches
Weight	155 pounds (70 kg)

FUNCTIONAL FEATURES

Pedal Step Height	0 to 10"
Arm Stroke Length	0 to 10"
Overall Climb Rate	Ability Of Person Climbing
Hydraulic Climb Rate Control	6-107 m/min
Hydraulic Force Control	0 To 500 lbs
Climb Angle	75 Degrees
Vertical Lift Factor (% slope)	96.6 Percent

USER ACCOMMODATIONS

Level of Physical Fitness	Novice To Elite
Climber's Height	4' 2" to 6' 7"
Climber's Weight	65 lbs. to 352 lbs.
Age and Sex	Any

MODULE DISPLAY FUNCTIONS

Exercise Time	0 to 99.9 Hours
Exercise Rate	0 to 351 FT/min
Exercise Distance	0 to 10,000 FT
Step Height	0 to 10 inches
Race against opponent	35 to 200 FT/min
Climb a Landmark	(Distance) 554 to 9731FT
Heart Rate Display	30 to 235 (BPM)
Calorie burn rate	0-2000
Display Units	Imperial and Metric
Audio	Volume Control
Power Transformer	110 Volt AC

TOOLS REQUIRED FOR ASSEMBLY OF A SINGLE UNIT:

- A. One Phillips screwdriver
- B. Two 9/16" wrenches
- C. Two able bodied persons are required for assembly

UNPACKING INSTRUCTIONS

The following items are packaged in the container.

EQUIPMENT: (single unit 108 CM)

- A. Vertical frame/post with control console attached
- B. Two foot pedals. Four hex head bolts, 3/8" x 1 1/2" long
- C. Two quick release hand grips
- D. (OPTIONAL) One pair of handle extenders, one pair of hand rail spacer, four screws, 1/4" x 4 1/4" long
- E. One front curved tubing base. Four 3/8" x 5/8" bolts
- F. One back straight tubing base. Two hex head bolts 3/8" x 3 3/4" long. Two 3/8" lock nuts
- G. One brace, post to back base. Two 3/8" lock nuts
- H. Two side handrails. One 3" hand rail spacer. Three hex head bolts 3/8 x 4 1/4" long for side hand rails and three 3/8" lock nuts
- I. One plastic Pump Cover. Four black Phillips pan head screws, No. 6 x 3/8" long
- J. One transformer. 110 volt AC Adapter

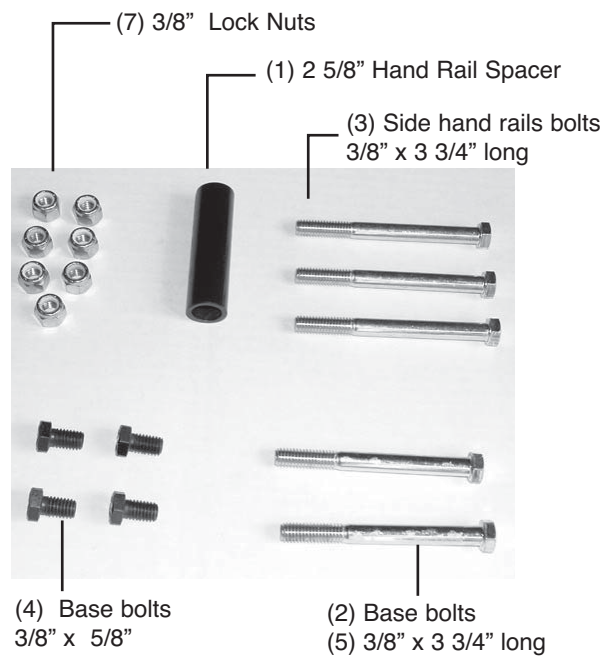

Attach the front curved tubular floor brace to the post. Using four hex head bolts, 3/8" x 5/8" long, screw down until firmly tight.

1. Remove the shipping container's top cover. Then remove two wooden cross supports that hold the mainframe down and the two bolts at the end of the container. Using two people, carefully remove the vertical mainframe from the container and lay the machine on the floor with pump supported on the wooden cross support (see photo below). Avoid lifting the machine by or setting the machine on any portion of the black plastic housing or plastic oil accumulator.

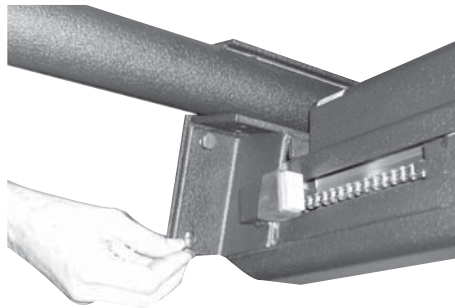

Screw in (4) self tightening base bolts.

Hydraulic pump

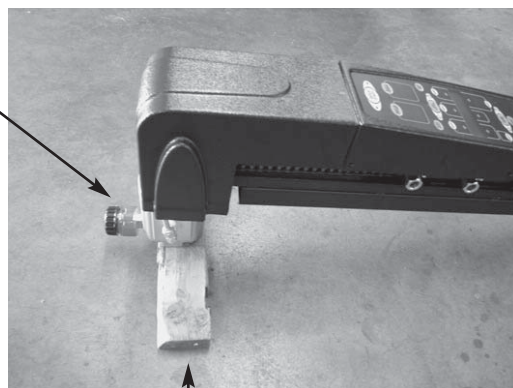

Support pump.

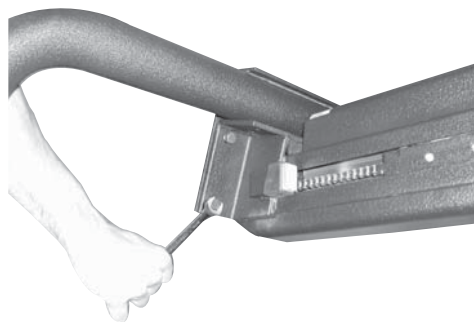

Securely **TIGHTEN** all (4) bolts.



Using two people lift and hold VersaClimber in upright position.



Attach back tubular floor brace to post with two hex head bolts, 3/8" x 33/4" long. (2) 3/8" lock nuts. **DO NOT TIGHTEN FULLY AT THIS TIME.**



Attach tubular brace between post and back tubular floor base with (2) 3/8" lock nuts. **DO NOT TIGHTEN FULLY.**



After tubular brace is in place, go back and **FULLY TIGHTEN** the two 33/4" long base bolts.



Then go back and **TIGHTEN FULLY** the TOP lock nut on the tubular brace.



Next, tighten the BOTTOM lock nut on the back brace to complete post assembly.



Attach foot pedals with “L” shape bracket pointing up, using (2) 3/8” x 1 1/2” long hex head bolts.

NOTE: We recommend replacing pedal shaft every 3 years.



Securely **TIGHTEN** foot pedals with 9/16” wrench.



Attach side handrails with (3) hex head bolts 4 1/4” long and (3) 3/8” lock nuts.

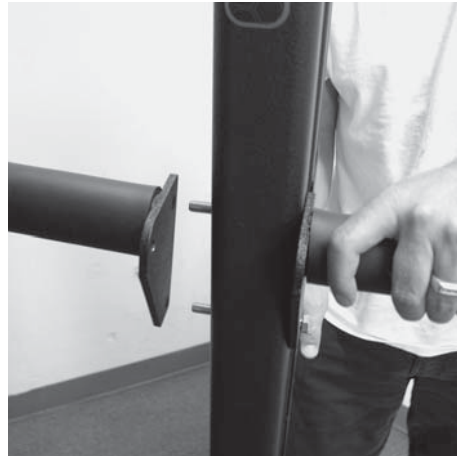

Join left and right hand rails.



Loosely attach two 3/8” lock nuts nearest to the inside center of machine.

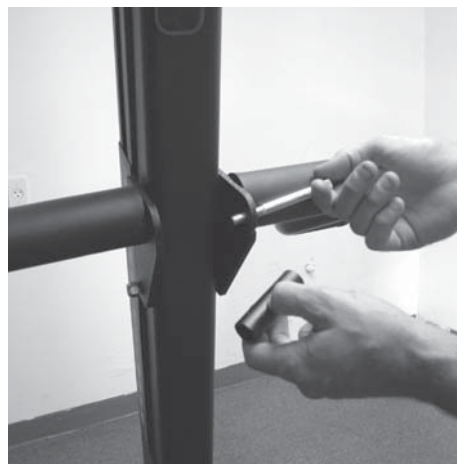

Insert 25/8” long spacer and **FULLY TIGHTEN** ALL three bolts and nuts with 9/16” wrench.

(OPTIONAL) ARM EXTENDERS

On the standard CM a person up to 6' 3" tall has a full arm extension while climbing. With optional arm extenders a 6' 9" person gets a full stretch while climbing.

Optional Arm Extender for additional reach and stretch.



Arm Extender Spacer

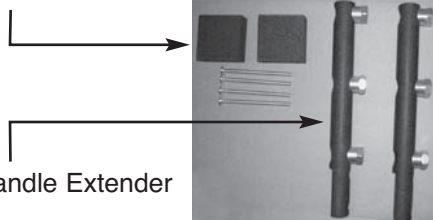

Arm/Handle Extender

(Optional) Attach each handle spacer and handle extender with two, 1/4" screws x 4" long.

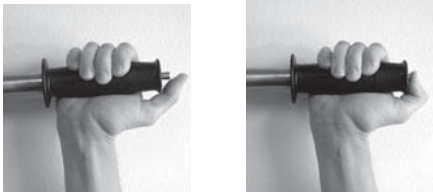

Install quick release handgrips by depressing pin with thumb and insert.



With the post supported or after VersaClimber is upright, slip pump cover into place. Attach with four Phillips pan head screws 1/4" x 3/8" long. **DO NOT OVER TIGHTEN.**



Plug the transformer into the back of the post and a 110 volt wall socket.

ASSEMBLY INSTRUCTIONS FOR HIGH-TRI AND HIGH-FIVE

Protect the oil reservoir and the black plastic computer housing by supporting the Versa Climber hydraulic pump on a block of wood or other spacer, (see page 9).



Attach the circular plate to the top of one VersaClimber with 4 hex head bolts, 3/8" x 11/4" long and 4 3/8" lock nuts. (Do not fully tighten).

Attach second VersaClimber to the circular plate in a similar fashion. Do not fully tighten nuts.

Lift assembly of two VersaClimbers upright. Place third VersaClimber into position and tighten bolts to circular plate **loosely**.

Connect the bases of the VersaClimbers together with the tubular floor ties using two hex head bolts 3/8" x 11/4" long and two lock nuts per machine.

To complete High-Tri or High-Five configuration securely tighten all bolts at the base of the machines and then in the circular plate at the top of machines.

Attach foot pedals with "L" shaped bracket pointing up, using two 3/8" x 11/2" long hex head bolts. **FULLY TIGHTEN.**

Attach handrails with three hex head bolts 3/8" x 31/2" long and one 25/8" long spacer.

(Optional) Attach each handle spacer and handle extender with two 1/4" screws x 4" long.

Install handgrips by depressing pin with thumb and insert.

MAINTENANCE INSTRUCTIONS

The VersaClimber consists of a mainframe that is supported on a stable 3 point base. A sprocket is attached to a hydraulic pump located at the top of the mainframe. The top handle sliding bars and bottom pedal sliding bars are connected with chain. These bars travel up and down inside the main frame on rollers and slide bearings. Sprockets located between the pedal bars and the handle bars are designed to synchronously increase the length of arm motion over the height of leg motion.

HAND GRIPS-The hand grips are a high quality rubber grip. The handgrips are replaceable with any good quality "flanged" grip from your local bike shop or contact Heart Rate Inc. for spares.

FOOT PEDALS-The foot pedals are made of a strong durable molded plastic. Every two months, place a few drops of light oil on the shaft at both ends of the pedal. The foot pedal straps are replaceable.

DISPLAY MODULE-The display module requires no maintenance. If a malfunction occurs, see trouble shooting on page 17 or contact the Heart Rate Inc's service department.

The module is secured to the machine with 4 screws and has easy to remove wire connectors. Repairs to the module must be made at the factory. If the unit is returned for repair include a brief description of the problem. Package the module carefully to avoid physical damage. The machine can be used while the electronics are off the machine for repair.

THE HYDRAULIC SYSTEM

The hydraulic resistance consists of a heavy duty reversible gear pump and a pressure flow control valve connected between the input and the output ports with high-pressure copper tubing. A clear oil filled reservoir is located on top of the pump to monitor oil level. Disregard any change in oil color. Hydraulic resistance is developed in a permanent closed loop system filled with oil that does not require changing.

When climbing, oil passes through the pressure control valve. Closing the valve increases climbing resistance and opening the valve decreases climbing resistance.

If a large amount of slack (more than 1/2" travel) develops when reversing the stepping motion, this indicates a possible loss of oil from the system. Visually check the fittings and the shaft seal for oil leaks. Tighten any leaking fitting 1/4 turn maximum. Then fill the reservoir with oil up to 1/2" from the top.

ROLLER, SLIDE BEARINGS AND TRACK LUBRICATION

The roller and slide bearings are made from high pressure Moly-Disulfide filled Nylon. This bearing material is expected to be maintenance free for years. The bearings and inner tracks of the rectangular tubing are lightly lubricated at the factory. The wear life and smooth operation of the machine can be assured by lubricating every six months or sooner if required with Super Lube Professional High Performance Spray Lubricant with PTFE.

NOTE:

SLIDE BEARINGS AND TRACKS REQUIRE CLEANING AND LUBRICATION WHEN THERE IS A NOTICEABLE INCREASE IN THE RESISTANCE TO MOTION OR A STICKY FEELING OF THE HANDGRIP AND FOOT PEDAL MOTION. THIS INCREASE IN RESISTANCE IS NOT CAUSED BY A LACK OF LUBRICATION. IT IS CAUSED BY AN ACCUMULATION OF LINT AND DUST IN THE LUBRICANT THAT IS DRYING OUT. IT IS THIS HIGHLY VISCOUS DRIED OUT LUBRICANT (TAR LIKE SUBSTANCE) THAT CAUSES THE INCREASE IN RESISTANCE. IT IS ONLY NECESSARY TO CLEAN THE TAR LIKE SUBSTANCE FROM THE POST TO RESTORE THE MACHINE TO FACTORY SMOOTH MOTION.

To clean, spray all internal accessible surfaces of the rectangular tubing with odorless paint thinner. With a rag, wipe the old oil, lint, dirt, etc. from all internal surfaces. Move the bars up or down to allow access to clean the foot pedal slots and handgrip slots. Move the machine through ten full cycles and clean again. When thoroughly clean, spray a very thin coat of Super Lube with PTFE on all internal surfaces of the rectangular tubing.

VERSACLIMBER WALL MOUNT OPTION INSTRUCTIONS

Step 1.

Determine if you will be securing your VC to a concrete wall or a drywall wall with wood studs. It is not recommended to secure a VC to a drywall wall that has steel studs.

Step 2.

If securing to a cement wall, go to Step 8. If you are securing to drywall with wood studs continue to next step (3).

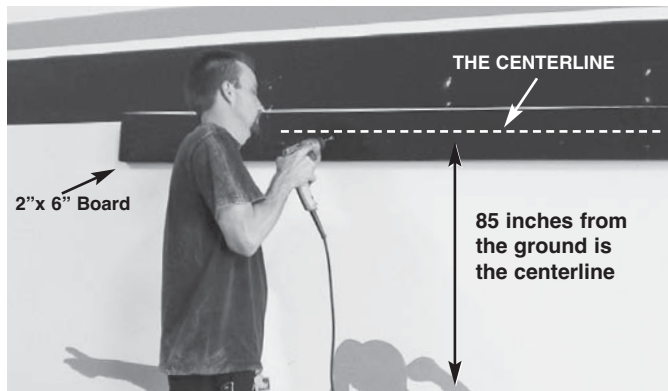

Locate the "center line" of the wood horizontally 85 inches above the floor and secure to at least 2 studs with wood screws or drywall screws at least 3" long.

Step 3.

A 2" x 6" piece of wood is recommended. The length of the board must span at least two wood studs in the wall when securing your VC. The number of installed VC's determines the length of board. For example, 2 VC's mounted requires a minimum board length of 6' long, properly secured to wall.

Step 4.

Attach the wall mount bracket to your VC centering the 4 bolts to allow adjustment forward and backward.

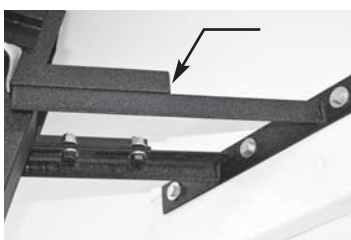
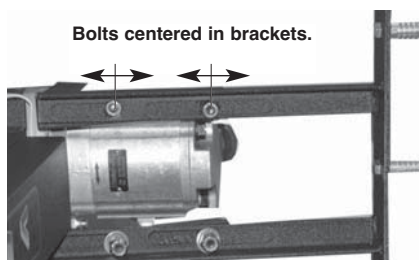

NOTE:
Before mounting to wall, make sure brackets are centered to allow forward and backward adjustment from wall. Brackets stack on top of each other.

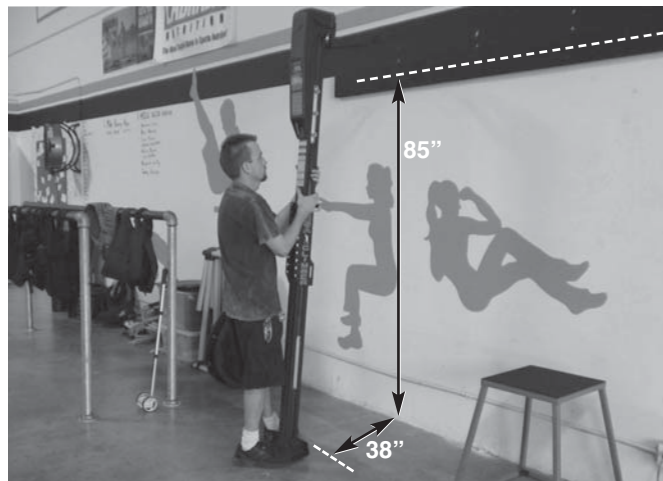

TOP:
85 Inches off floor to establish centerline.

BOTTOM:
38 Inches base plate from wall.

Step 5.

Stand your VC up and rest the bracket against the piece of wood mounted to the wall. Place the holes of the bracket on the center line you have marked. The front base holes of your VC should be approx. 38 inches in front of wall. Distance can vary depending on wall, baseboards and or where the bracket is positioned.

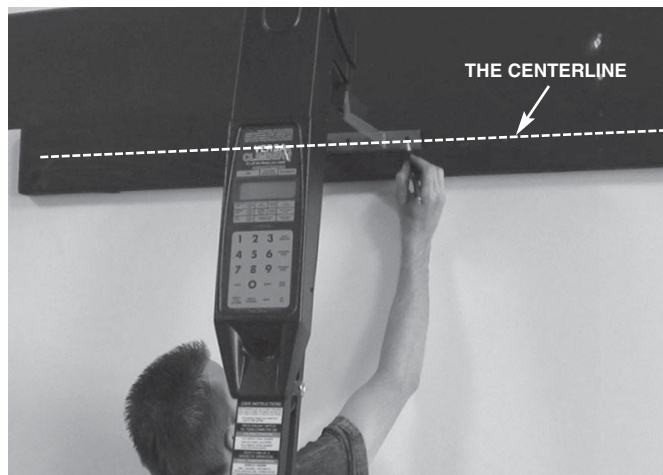

Step 6.

Mark the 3 holes on your "center line". Remove your VC and place to the side. Drill the 3 holes through the wood support with a 3/16" drill:

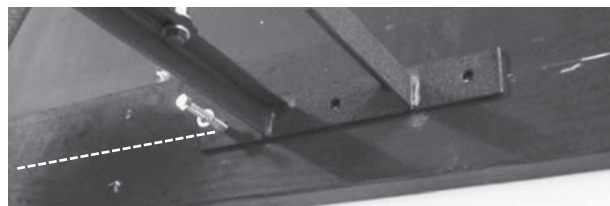

Step 7.

Place your VC back in place and align the 3 holes. Secure with the three 5/16" lag bolts and washers supplied then go to Step 13.

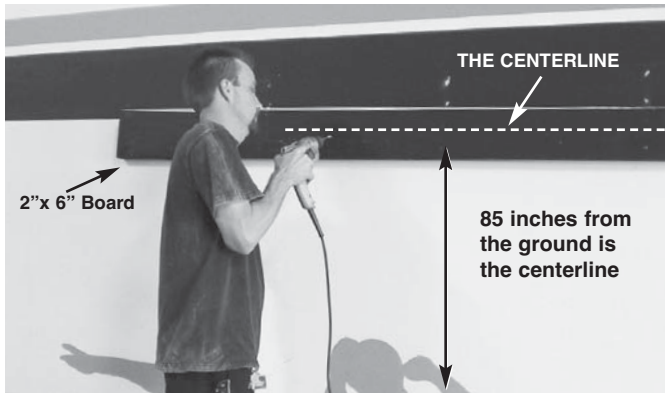

Step 8.
Mounting your VC to cement wall. Mark a line horizontally 85 inches from the floor.

Step 9.
Attached the bracket to you VC using the four bolts, washers and nuts supplied, centering the four bolts to allow adjustment forward and backwards.

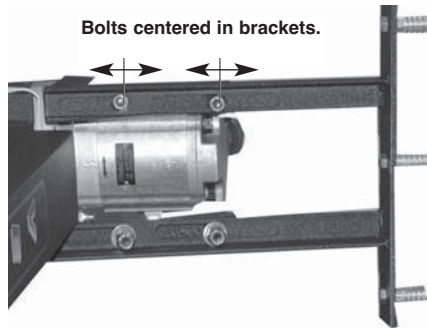

NOTE:
Before mounting to wall, make sure brackets are centered to allow forward and backward adjustment from wall.



Step 10.
Stand your VC up and rest the bracket against the wall. Place the holes of the bracket on the center line you have marked on the wall. The front base holes on the VC should be approximately 38 inches from the wall. This distance may vary depending on the wall, base boards, and or where the bracket is positioned.

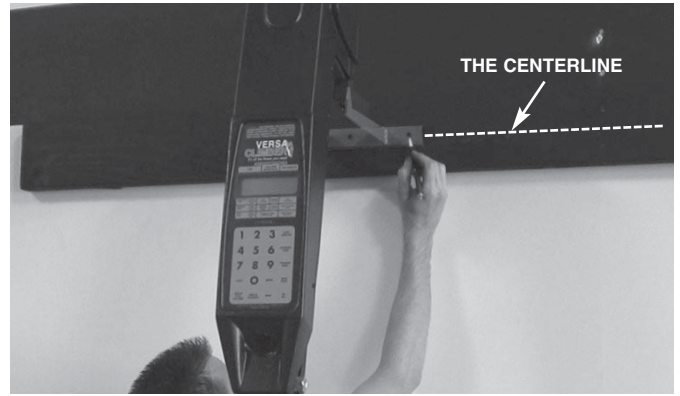

Step 11.
Mark the three holes on the centerline. Remove your VC and place to the side. Drill the three holes using 1/2" cement drill bit at least 1 inch deep.

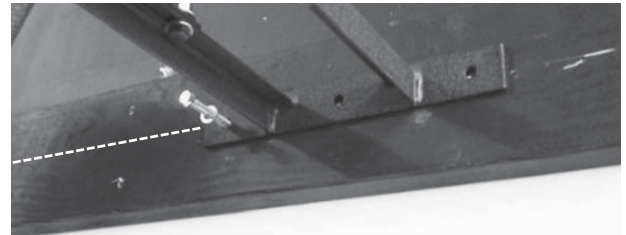

Step 12.
Tap in the three lag shields supplied. Place the VC back in place aligning the three holes secure with three 5/16" lag bolts plus washers supplied.

NOTE:
For multiple units side by side, spacing should be a minimum of 40" from the center of the vertical center line of each unit.

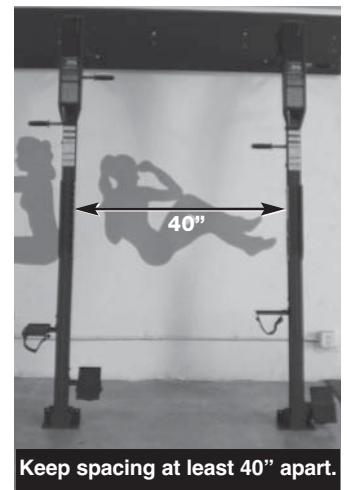

Step 13.
Your VC is now secure to wall. You can adjust your VC closer or farther from the wall to avoid small obstructions. The closer your VC is to the wall the more stable it will be. Adjust your VC if necessary. Determine if the base needs to be secured to the floor for extra stability. Climb on your VC to see if the base moves. If you want to secure to the floor, continue to next step.

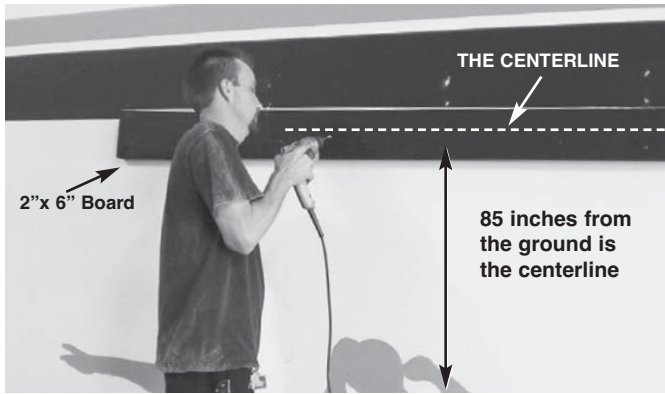

Step 8.
Mounting your VC to cement wall. Mark a line horizontally 85 inches from the floor.

Step 9.
Attached the bracket to you VC using the four bolts, washers and nuts supplied, centering the four bolts to allow adjustment forward and backwards.

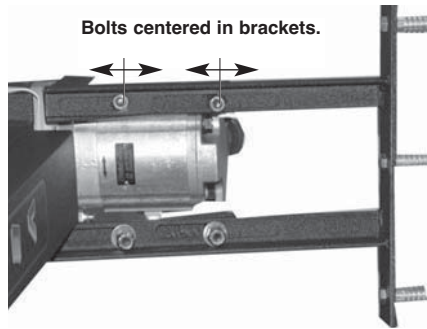

NOTE:
Before mounting to wall, make sure brackets are centered to allow forward and backward adjustment from wall.



Step 10.
Stand your VC up and rest the bracket against the wall. Place the holes of the bracket on the center line you have marked on the wall. The front base holes on the VC should be approximately 38 inches from the wall. This distance may vary depending on the wall, base boards, and or where the bracket is positioned.

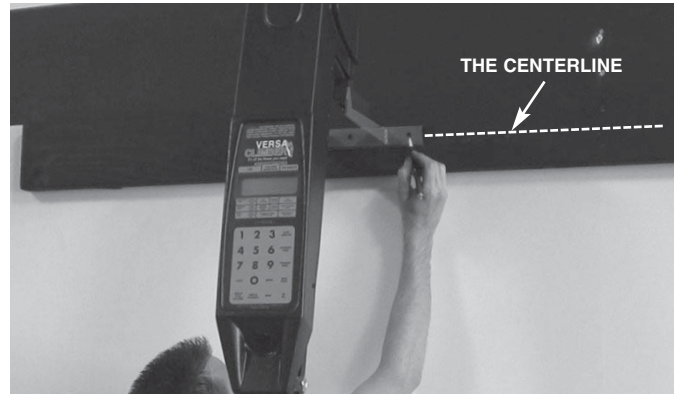

Step 11.
Mark the three holes on the centerline. Remove your VC and place to the side. Drill the three holes using 1/2" cement drill bit at least 1 inch deep.

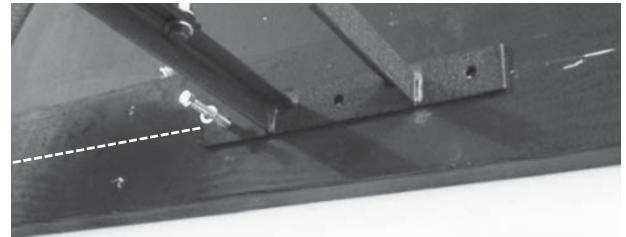

Step 12.
Tap in the three lag shields supplied. Place the VC back in place aligning the three holes secure with three 5/16" lag bolts plus washers supplied.

NOTE:
For multiple units side by side, spacing should be a minimum of 40" from the center of the vertical center line of each unit.

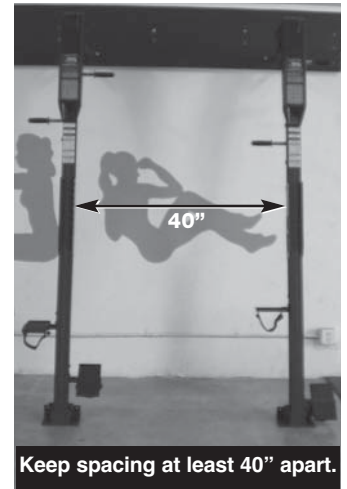

Keep spacing at least 40" apart.

Step 13.
Your VC is now secure to wall. You can adjust your VC closer or farther from the wall to avoid small obstructions. The closer your VC is to the wall the more stable it will be. Adjust your VC if necessary. Determine if the base needs to be secured to the floor for extra stability. Climb on your VC to see if the base moves. If you want to secure to the floor, continue to next step.

CHAIN LUBRICATION

Lubricate chains every 2,000 hours of operation with light grease. Before lubrication clean the chain with paint thinner on a toothbrush and then use toothbrush to spread a light coat of grease on the side of the chain that contacts the sprocket.

CHAIN ADJUSTMENT

The frequency of chain adjustment cannot be accurately predicted. It is a function of total hours of use, total feet climbed, weight and strength of people climbing and the level of routine lubrication maintenance.

CLEANLINESS

It is recommended that the VersaClimber be placed on approximately a five-foot square vinyl floor mat because users are going to perspire profusely. To prevent corrosion, it is recommended that the machine be wiped clean with soap and water at a "good housekeeping frequency" to remove salts and other body residues. This should be done no less than once a week. It is further recommended that the machine be cleaned and waxed once a month with any good quality car wax.

TROUBLE SHOOTING

If a malfunction occurs, please refer to the following SYMPTOM guide for instruction.

NOTE:

TO RECEIVE HELP OR TO EXPEDITE SERVICE PLEASE CALL THE FACTORY. RETURN ALL PARTS TO THE FACTORY WITH A BRIEF NOTE STATING THE NAME, ADDRESS, PHONE NUMBER, CONTACT NAME AND A DESCRIPTION OF THE SYMPTOM. IF A DESCRIPTION OF THE PROBLEM IS NOT INCLUDED WITH THE RETURNED PART, REPAIRS MAY BE SIGNIFICANTLY DELAYED.

CALL 1.800.237.2271

SYMPTOM: **ALL ZEROS ARE REGISTERING ON MODULE**

If all zeros register on the display when the machine is in motion, there could be a faulty encoder circuit board, broken or loose wire connectors.

With the top, black, plastic cover removed, slowly move the handles up and down. A plastic encoder disc should be seen rotating through a slot that houses sensors. Check to be sure that the disc is clean and the encoder circuit board and the module are in tact. If no mechanical malfunction is visible, the encoder circuit board may be faulty and should be replaced. If necessary, contact Heart Rate, Inc. for further information.

SYMPTOM: **LCD DIGITS FAIL TO ILLUMINATE**

If the display window is ruptured and the glass top on the LCD is broken, the digits under the broken area will fail to illuminate. The module will need to be removed and returned to Heart Rate, Inc. for LCD replacement and repair. To remove the module, remove the four screws that mount the module to the machine and disconnect the wires from the module. The machine can be used while the module is out for repair.

SYMPTOM: **MACHINE SQUEAK**

A lack of lubrication can cause a squeak in the foot pedal shaft. If rotating the foot pedal while standing on the pedal causes a squeak, lubricate the shaft/pedal interface. If squeak remains, remove the snap ring from the end of the pedal shaft with snap ring pliers being careful not to over extend the ring. Remove the plastic foot pedal and degrease the shaft and pedal hole. If necessary, use fine sandpaper to smooth the shaft surface. Apply grease liberally and reassemble the pedal. Be sure that the snap ring is fully engaged in the snap ring groove.

**SYMPTOM:
MACHINE IS “STICKY”,
IRREGULAR OR HARD TO MOVE**

The foot pedals and handgrips are attached to metal bars that move up and down inside C shaped metal channels. The bars have plastic rollers and slides that guide the bars through the channels. Over time the lubricant in the channels picks up dust and lint and dries out producing a “sludge” tar like coating that prevents smooth machine operation. Remove the tar like coating with paint thinner on a rag and the machine will function like brand new.

**SYMPTOM:
OIL LEAK FROM HYDRAULIC
ADJUSTMENT KNOB**

An oil leak from the hydraulic knob (brass knob) indicates either a loose connection or a malfunction in the needle valve. Tighten the nut on the needle valve if it is loose. If leak persists the valve must be replaced. Do not remove the defective valve until you receive the new one. Detailed installation instructions will be included with the replacement valve.

**SYMPTOM:
OIL LEAK FROM RESERVOIR
ON TOP OF HYDRAULIC MOTOR**

If oil leaks from the top seal between the black plastic cap and the plastic bowl, tighten cap by hand. If oil leaks from the threads at the base of the accumulator, tighten by turning clockwise with a wrench. If reservoir is physically damaged and a replacement is required, do not remove the reservoir until you receive a new one. The replacement reservoir will include detailed installation instructions. **DO NOT USE THE MACHINE UNLESS THE RESERVOIR IS AT LEAST 3/4 FULL OF OIL.**

Write down additional notes here:

SPARE PARTS LIST

In the event that a replacement part is ordered from the factory, Please refer to the following spare parts list for the correct part description and part number. This information will expedite your shipment when calling our Service Department.

Electronics

CM Module (108/109)015-06-000CM
Tach Assembly, V765 (Bracket, PCB Assy, Cable)015-12-000
Encoder Disc013-01-0016
Key Pad/LCD/Label Assembly, CM015-05-002AB
Power Supply	60069
Speaker Assembly015-09-000
Bulkhead Connector PCB Assembly, CM015-19-000
Bulkhead Connector Assembly (PCB & cable), CM015-16-000
Tach, PCB Assembly, CM015-14000
Tach, Cable Assembly, CM015-15000
Tach Bracket015-13-000
Top Cover, Speaker CM015-10-000
Power Supply UK, CM	60070

Moving Parts

Foot Pedal Assembly.	101-04-000
Foot Pedal Straps	008-03-000
Foot Pedal Connector, (Plastic Triangle)	008-00-007
Quick Change Handle (1)	101-06-000
Quick Change Running Handle (1)	101-03-000
Handle Grip Only.	30009
Idler Chain, CM	182-02-007
Top Chain, CM.	182-02-005
Lower Chain, CM.	182-02-006
Idler Sprocket, CM.	182-00-002
DBL-Chain, CM	182-02-008
Bottom Chain, CM.	182-02-009
Top Bar	182-00-004
Bottom Bar	180-03-001
Slides.	003-00-009
Rollers	003-00-005
Flange	30033
Bearing for Flange.	30044
Sprocket, DBL-35,CM	182-00-002
Bearing	30019
Arm Extender Bar Assembly.	182-02-000

Hydraulic Pump

Pump Assembly, CM039-01-000
Pump Sprocket Bushing (Post 1990)	30065
Pump Sprocket	30025
Accumulator	30038
Valve Stem	30027
Valve Stem Cover	00190

Structural

Brackets - Hi-Tri Assembly (108)048-00-000
Brackets - High Five Assembly (108)050-00-000
Base Assembly, (all parts)182-03-000
Brace182-00-008
Bumper Stoppe101-00-008
Post Assembly, SM183-01-001
Back Base Support182-03-001
Front Base Support182-03-004
Ears - Left147-00-005
Ears - Right147-00-004
Stopper101-00-008
Super Lube with PTFE	30090
Rail Right Side182-00-005
Rail Left Side182-00-006
Rail End Cap30031
Rail Foam60046

VERSACLIMBER THREE-YEAR LIMITED WARRANTY

1. Heart Rate Inc. (H.R.I.) warrants to the original purchaser that the CM is free from defects in material and workmanship under normal use and proper maintenance with a three year limited warranty subject to the terms and conditions hereafter set forth. Except for the above warranty, it is expressly agreed that NO WARRANTY OF MERCHANTABILITY OR FITNESS FOR A PARTICULAR PURPOSE or of a particular use nor any warranty of any kind whatsoever express, implied or statutory is made by H.R.I.
2. This warranty does not cover any damage caused misuse, tampering, negligence, accidents, abnormal conditions, lack of adequate maintenance or unauthorized service or alterations to the product.
3. Liability of H.R.I. is limited to either repair or replacement of the defective part or the replacement of the machine at the option of H.R.I. on an exchange basis, with the customer bearing all costs of shipping and handling to and from the factory.
4. Length of Warranty, Parts.

ITEM PARTS REPLACEMENT:

3 YEAR

FRAME, HAND RAILS, BASE SUPPORT	3 YEARS
HYDRAULIC MOTOR	3 YEARS

2 YEAR

FOOT PEDALS	2 YEARS
HANDLES	2 YEARS
CHAINS AND SPROCKETS	2 YEARS
ROLLERS AND SLIDES	2 YEARS

1 YEAR

ELECTRONICS	1 YEAR
HAND GRIP	1 YEAR
FOOT PEDAL STRAPS	1 YEAR
HANDRAIL FOAM COVERS	1 YEAR

5. Length of Warranty, labor

During the first year, all labor is covered by the warranty. All labor repairs for warranty and non-warranty parts will be performed at the factory. The cost of shipping to and from the factory is the responsibility of the warranty.

6. This warranty does not cover paint deterioration, discoloration, chipping or rust.

7. After all of the foregoing conditions have been complied with, if H.R.I. shall thereupon attempt repairs and /or replacements which shall for any reason fail, H.R.I. shall be allowed to continue to attempt to remedy any defects for so long a period of time as, In H.R.I. sole judgment, such attempt is justified.

8. The foregoing shall be buyer's sole and exclusive remedy, whether based on tort or otherwise, and H.R.I. shall not be liable for any injuries to persons or property. In no event shall H.R.I. be liable for incidental or consequential damages for commercial losses or for any other loss or damages except as above set forth.

9. This warranty is expressly in lieu of all other warranties, express or implied, and of all other obligations or liabilities on the part of H.R.I. No person, firm or corporation is authorized to assume any other liability on behalf of H.R.I.

CLOSING COMMENTS

This instruction manual, like any instruction manual, is not and cannot be 100% complete. Please contact us if you have any questions or comments after thoroughly reading this manual. We always appreciate receiving inputs from users.



1411 E. Wilshire Ave.
Santa Ana CA 92705

1.800.237.2271

ph: (714) 850.9716 fx: (714) 755.5749

info@heartrateinc.com | www.versaclimber.com